

Hydrotechnical Considerations



Overview

- Hydrotechnical Design
- River Issues
 - Lateral Stability
 - Vertical Stability
 - Blockage - ice, drift
- River Protection Works

Hydrotechnical Design

The Hydrologic Cycle

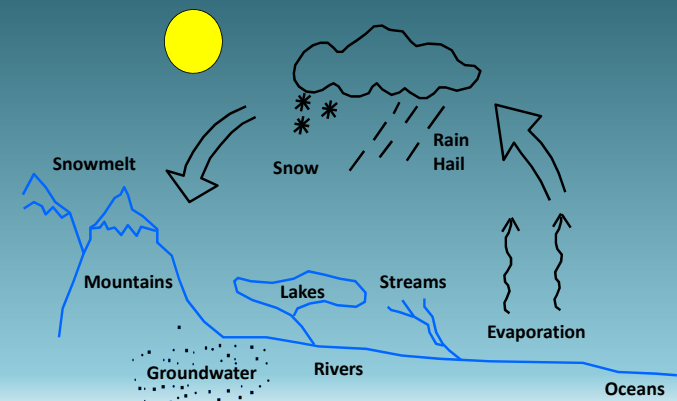

Drainage Basin Parameters

- Area
- Shape
- Slope
- Storage
- Density
- Vegetation
- Soil Type
- Initial Moisture

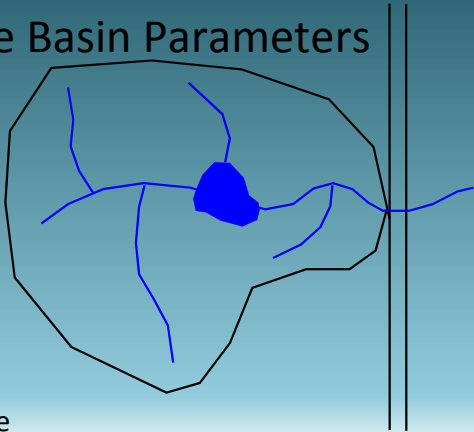

Runoff Response Variation Across Alberta

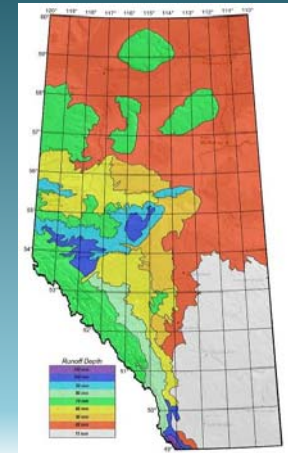

Hydrotechnical Design Guidelines

Channel Capacity

- channel size result of long-term runoff
- channel size affects routing of runoff
- typical channel
- activate overbank storage

Historic Highwater Data

- HWM – AT, AE, WSC, site, airphoto, news
- Location, description

Runoff Potential

- Limit on supply of runoff
- Unit discharge

Hydraulic Definitions

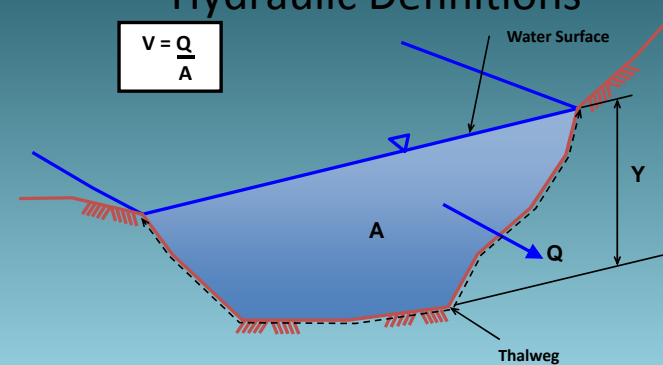

Flow Constriction - Stream Crossing

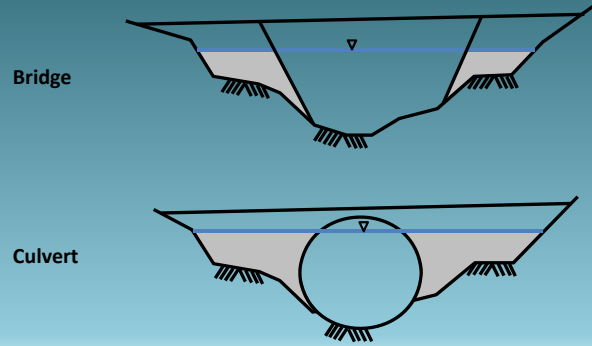

Flowlines - Before Constriction

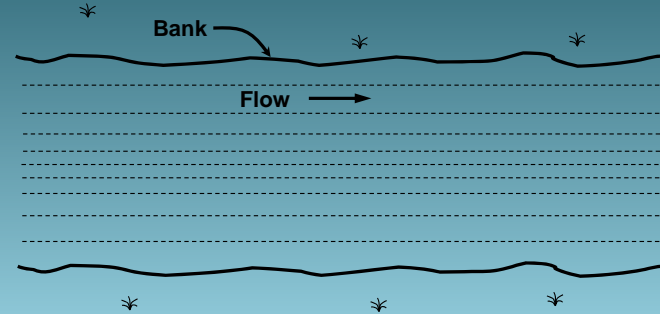

Flowlines - After Constriction

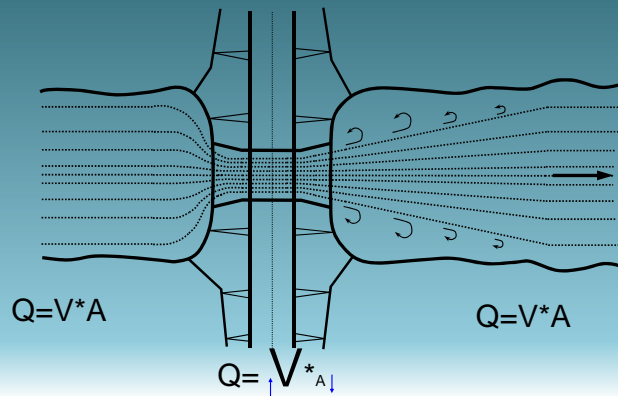

Flow Profile - After Constriction

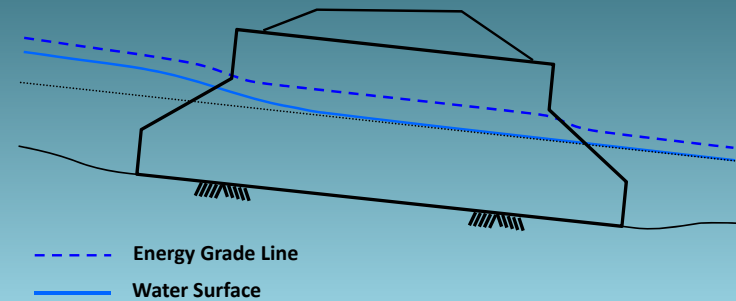

File 00278 - Battle River



File 00278 - Battle River



File 00278 - Battle River



File 75194 - Simonette River



File 75194 - Simonette River



File 75194 - Simonette River

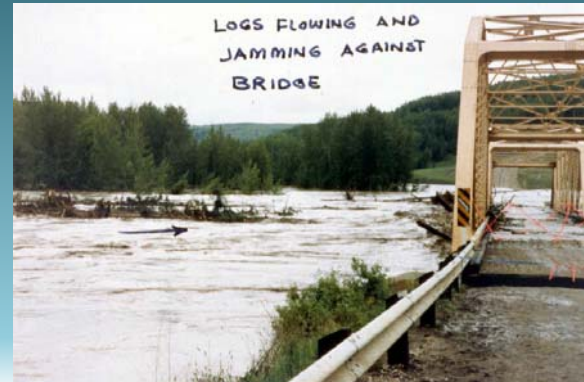

File 75194 - Simonette River



File 75194 - Simonette River



File 75194 - Simonette River



File 75194 - Simonette River



File 75194 - Simonette River



File 07107 - Iron Creek



BF76474 – Smoky River at Grande Cache



Technical Standards Branch
Class B Bridge Inspection Course



File 80827 - Nelson Creek



Technical Standards Branch
Class B Bridge Inspection Course



File 80827 - Nelson Creek



Technical Standards Branch
Class B Bridge Inspection Course



File 79475 - Bald Mountain Creek



Technical Standards Branch
Class B Bridge Inspection Course



File 79475 - Bald Mountain Creek



File 79475 - Bald Mountain Creek



File 79475 - Bald Mountain Creek



File 01324 - Pigeon Creek



File 01324 - Pigeon Creek



File 78230 - Brewster Creek



File 81653 - Watercourse



River Issues

Lateral Stream Stability

Stability of Stream Types

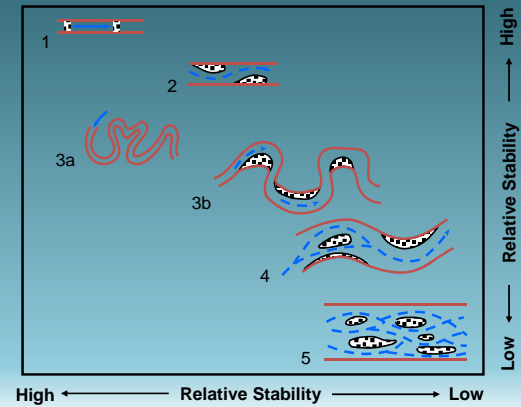

BF9259 – Freeman River

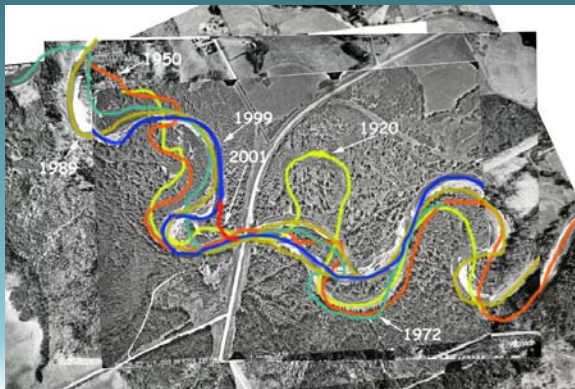

BF8036 – Redwillow River



BF13078 – Little Red Deer River



File 81113 - Marten Creek



File 75904 - Island Creek



File 75904 - Island Creek



File 75904 - Island Creek



File 73204 - Whitehorse Creek



File 73204 - Whitehorse Creek



File 73204 - Whitehorse Creek



File 73204 - Whitehorse Creek



File 73204 - Whitehorse Creek



Blockage - Drift, ice ...

File 78889 - Whitecourt Creek



File 71979 - Heart River



File 72964 – Howard Ck



Drift accumulation
can increase
velocities around
piers



BF 6754 Bow River at Cluny



Ice scarring on trees



Ice impact damage and abrasion on piers



Other debris?



Vertical Stream Stability

Typical Stream Profile

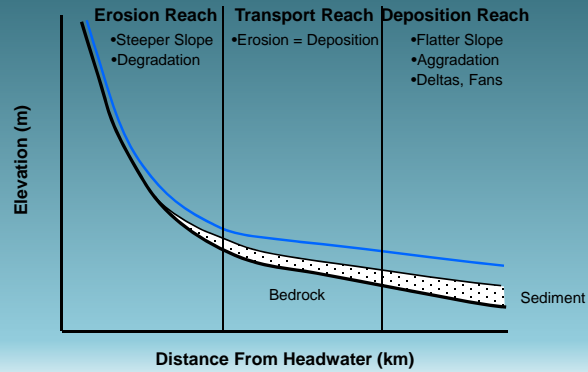

Technical Standards Branch
Class B Bridge Inspection Course



File 76995 - Malcolm Creek



Technical Standards Branch
Class B Bridge Inspection Course



File 76617 - Cougar Creek



Technical Standards Branch
Class B Bridge Inspection Course



File 76617 - Cougar Creek

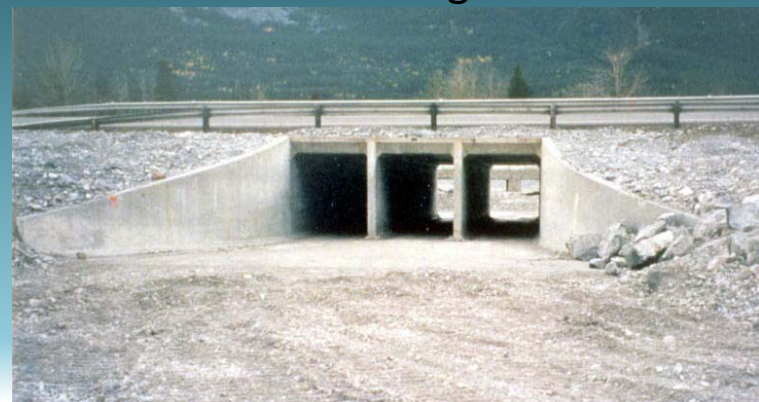

Technical Standards Branch
Class B Bridge Inspection Course



River Response

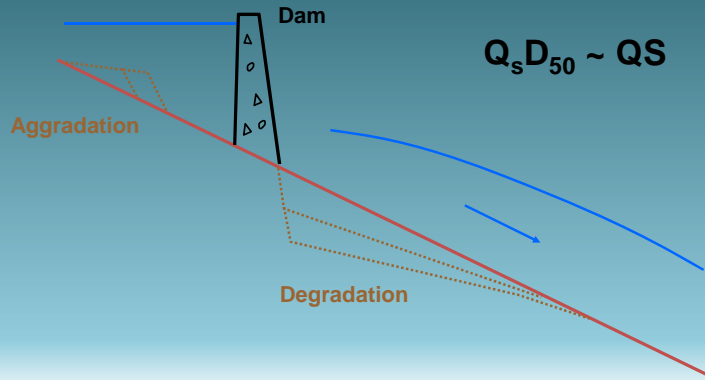

Technical Standards Branch
Class B Bridge Inspection Course



BF74852 – Bear River



Technical Standards Branch
Class B Bridge Inspection Course



BF74852 – Bear River



Technical Standards Branch
Class B Bridge Inspection Course



BF73235 – Cucumber Ck

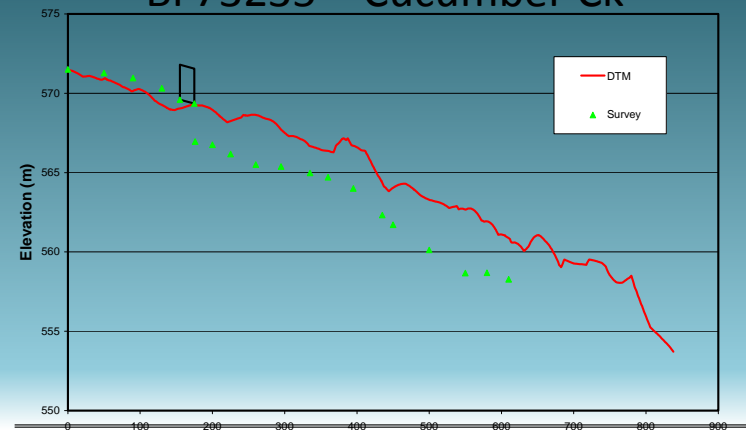

Technical Standards Branch
Class B Bridge Inspection Course



BF73235 – Cucumber Ck



BF73235 – Cucumber Ck



General Scour

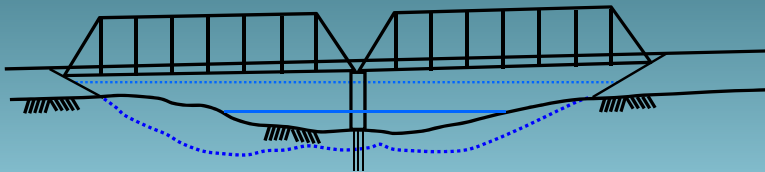

BF74710 – Berland River



Local Scour Profile

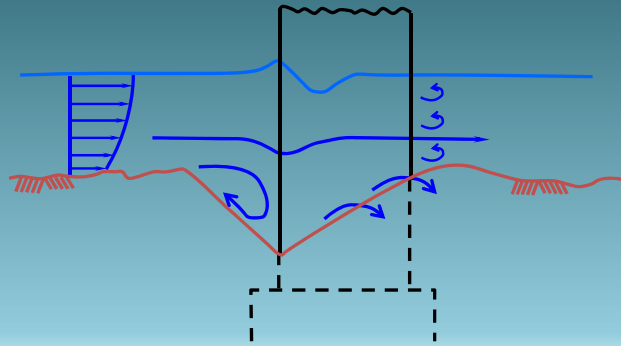

Local Scour in Plan View

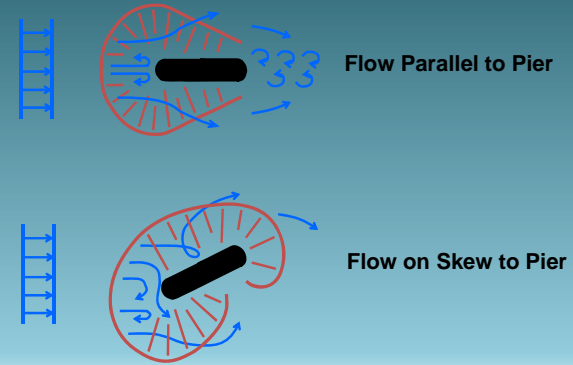

Smoky River CanFor Bridge

Failure of a pier on spread footing due to general scour



BF 78104 McLeod River near Peers - alignment problem





River Protection Works

Typical Rock Riprap Section

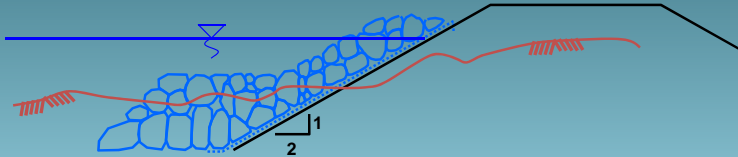

Location of River Protection Works

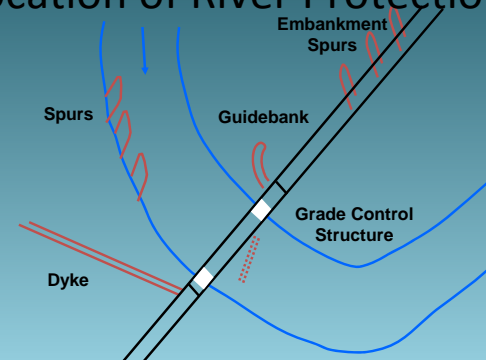

Oldman River at Monarch



Hydrotechnical Considerations

File 81795B - Red Deer River (1992)



Technical Standards Branch
Class B Bridge Inspection Course



Hydrotechnical Considerations

File 81795B - Red Deer River



Technical Standards Branch
Class B Bridge Inspection Course



Hydrotechnical Considerations

File 81795B - Red Deer River



Technical Standards Branch
Class B Bridge Inspection Course



File 81795B - Red Deer River



File 81795B - Red Deer River



File 81795B - Red Deer River (1999)



File 81778B - Wapiti River



File 81778B - Wapiti River

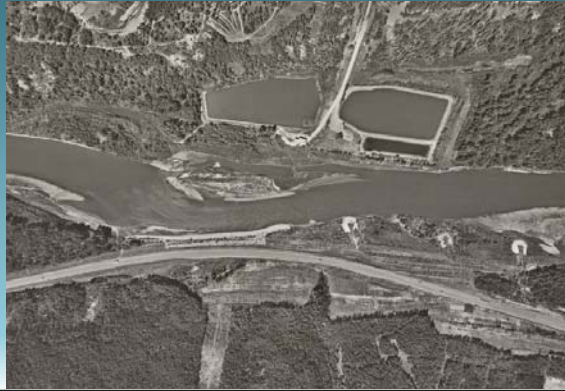

File 81793B - Swan River



File 81793B - Swan River

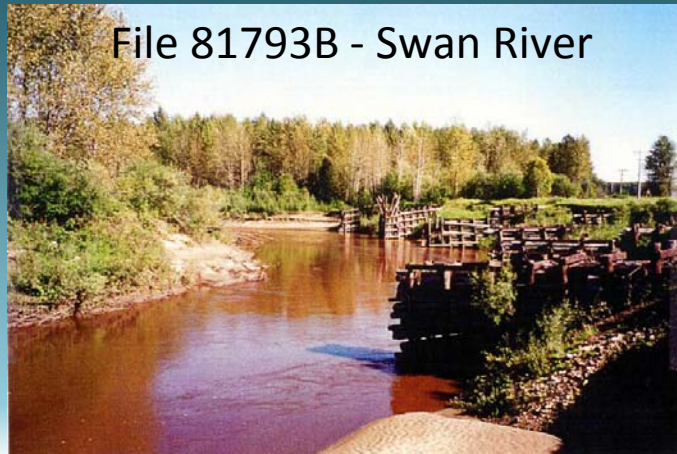

File 81793B - Swan River

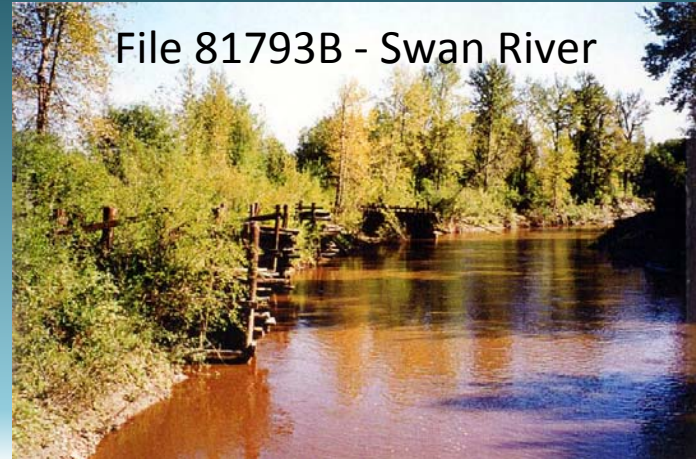

...Questions?



Technical Standards Branch
Class B Bridge Inspection Course

